

# Typ 0 603 269 2.. = PAS 1000

Stand ~~89-09~~  
Issue 95-01

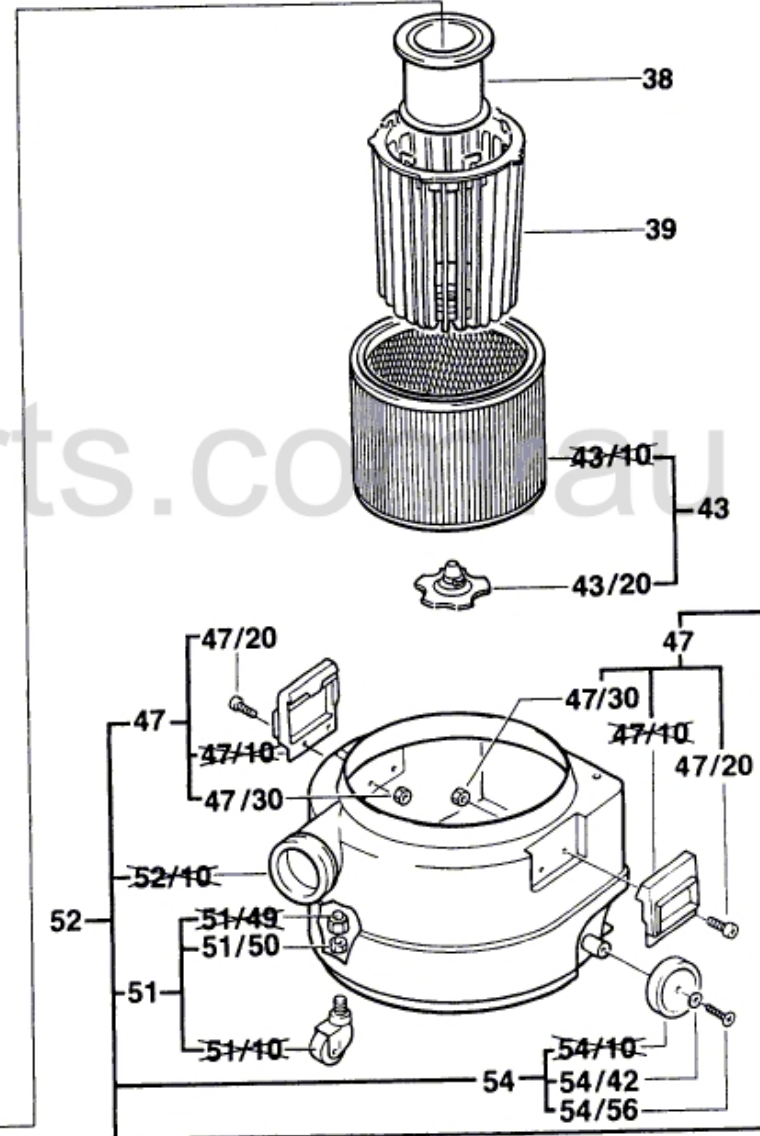
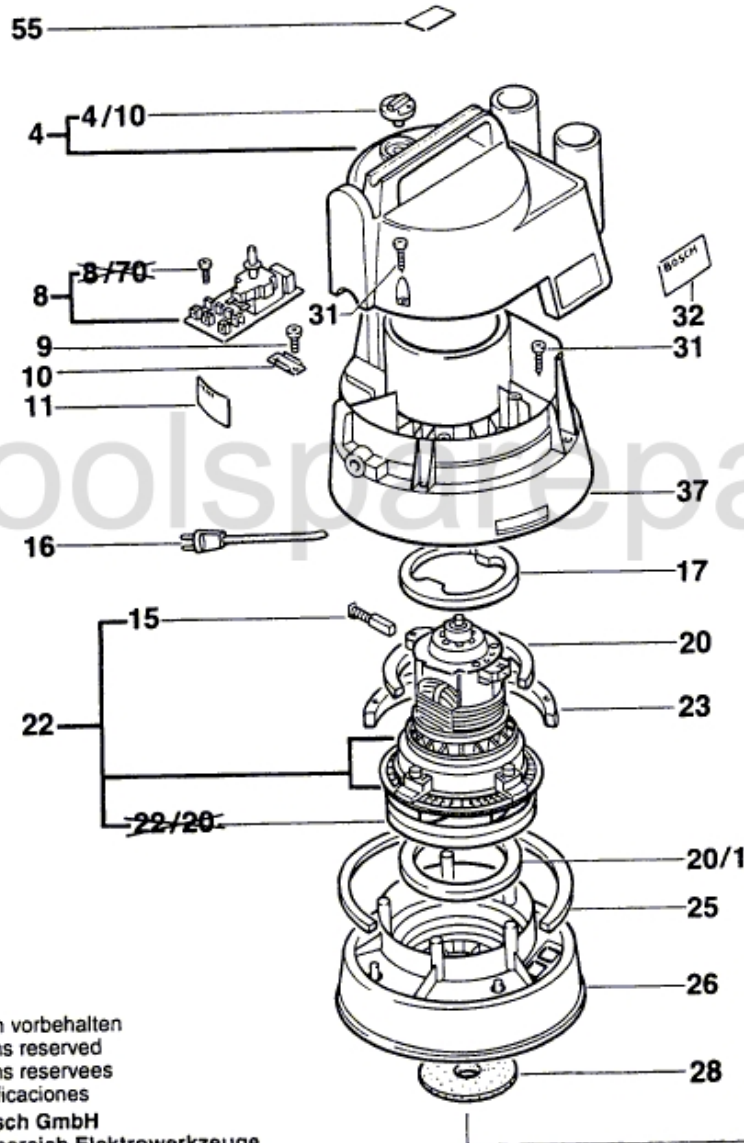
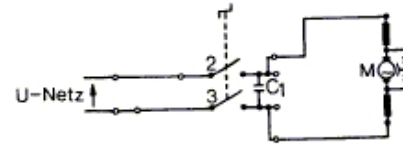

Änderungen vorbehalten  
Modifications reserved  
Modifications reserves  
Salvo modificaciones  
Robert Bosch GmbH  
Geschäftsbereich Elektrowerkzeuge  
70745 Leinfelden-Echterdingen